

E3332
REV F 02/17/2020



The Signature of Quality®



Item _____

**REFRIGERATED SELF-SERVICE
HIGH PROFILE
MODEL ERSSHP378SC-5
ERSSHP478SC-5
ERSSHP678SC-5**



KEEP THIS MANUAL FOR FUTURE REFERENCE

Engineering and technical data are subject to change without notice.

FEDERAL INDUSTRIES
Toll Free 1(800) 356-4206

215 FEDERAL AVE.
WI Phone (608) 424-3331

Belleville, WI 53508
Fax: (608) 424-3234

CONTENTS

INTRODUCTION	1
WARNING LABELS & SAFETY INSTRUCTIONS.....	2
INSTALLATION INSTRUCTIONS.....	3
Locating The Display Case	3
Removing Case From Shipping Skid & General Installation.....	3
Leveling the case.....	3
Grill Removal.....	4
Condensate Evaporator	4
Lights.....	4
ELECTRICAL INFORMATION & GROUNDING	5
Cord Connected	5
OPERATING INSTRUCTIONS.....	6
Initial Start-Up	6
Light Switch and Lights	6
Digital display.....	6
Placing Product In Case.....	6
Energy saving night curtain	6
Electronic Temperature Control settings	7
Powering On Control.....	7
Adjusting The Set Point.....	8
Error Codes	9
CONTROL OPERATION.....	10
Electronic Control	10
Operation.....	10
Control Sensor Locations.....	11
Control Factory Settings	11
Electronic Control	12
Defrost cycle.....	12
Minimum run time	12
Maximum run time	12
REFRIGERATION OPERATION.....	13
Self-Contained Models.....	13
Self-Contained Refrigeration Operation	13
Dual Pressure Control (Self-Contained Models Only)	13
SHELVES.....	14
CLEANING INSTRUCTIONS	15
Cleaning The Condenser Filter	15
Cleaning Condenser Coil	15 & 16
Cleaning Acrylic Air Deflector.....	16
Daily Cleaning.....	17
Weekly Cleaning.....	18
SERVICE INFORMATION	19
Pre-Service Checklist	20
Case Does Not Operate.....	20
Case Temperature Too Warm	20
Lights Do Not Operate	20
Over Flow Of Condensate Evaporator	20
Special Service Situations	21

SALE & DISPOSAL21
 Owner Responsibility 21
REFRIGERATION & ELECTRICAL DATA – ERSSHP378..... 22 & 22A
REFRIGERATION & ELECTRICAL DATA – ERSSHP478..... 23 & 23A
REFRIGERATION & ELECTRICAL DATA – ERSSHP678..... 24 & 24A
REPLACEMENT PARTS – ERSSHP378..... 25
REPLACEMENT PARTS – ERSSHP478..... 26
REPLACEMENT PARTS – ERSSHP678..... 27
ERSSHP DISPLAY AREA & VOLUME..... 28
WIRING DIAGRAMS – ERSSHP378, 478 & 678 29 THRU 32

INTRODUCTION

Thank you for purchasing a Federal Industries Merchandiser. This manual contains important instructions for installing and servicing the RSSM, Refrigerated Self-Service Merchandisers. A repair parts list is also included in the manual. Read all of these documents carefully before installing or servicing your case.



NOTICE

Read this manual before installing your case. Keep this manual and refer to it before doing any service on the equipment. Failure to do so could result in personal injury or damage to the case.



NOTICE

Installation and service of the electrical components in the case must be performed by a licensed electrician.

The portions of this manual covering components contain technical instructions intended only for persons qualified to perform electrical work.



DANGER

Improper or faulty hookup of electrical components in the case can result in severe injury or death.

All electrical wiring hookups must be done in accordance with all applicable local, regional, or national standards.

NOTE: UNIT MUST BE GROUNDED

REGISTRATION & SERIAL NUMBER

It's important to keep a record of the model and serial number of your merchandiser for warranty and part identification. Please write them here for your quick reference.

Register your product online! Visit our website at www.federalindustries.com and register your product today.

Case Model _____ Serial Number _____

We're here to provide you with the best possible experience with your new product, however, we cannot cover everything about your merchandiser in this manual, so if you have any additional questions or issues, please see the SERVICE INFORMATION PAGE to find who you should contact.

WARNING LABELS

SAFETY INSTRUCTIONS



This is the safety-alert symbol. When you see this symbol on your case or in the manual, be alert to the potential for personal injury or damage to your equipment.

Be sure you understand all safety messages and always follow recommended precautions and safe operating procedures.



NOTICE TO EMPLOYERS

You must make sure that everyone who installs, uses, or services your case is thoroughly familiar with all safety information and procedures.

Important safety information is presented in this section and throughout the manual. The following signal words are used in the warning and safety messages:

DANGER: Severe injury or death will occur if you ignore the message.

WARNING: Severe injury or death can occur if you ignore the message.

CAUTION: Minor injury or damage to your case can occur if you ignore the message.

NOTICE: This is important installation, operation, or service information. If you ignore the message, you may damage your case.

The warning and safety labels shown throughout this manual are placed on your Federal Industries case at the factory. Follow all warning label instructions. If any warning or safety labels become lost or damaged, call our customer service department at 1(800) 356-4206 for replacements.

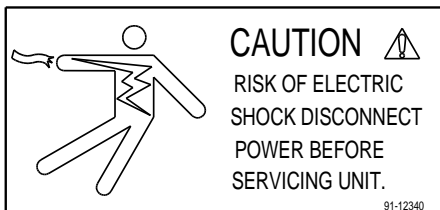

This label is located on the back of the display case on the front of the case behind the access panel.

This label is located below the display pan.

INSTALLATION INSTRUCTIONS

Locating the Display Case

This case is designed for indoor use only.

The case should be located where it is not subjected to the direct rays of the sun, heating ducts, grills, radiators, or ceiling fans, nor should it be located near open doors or main door entrances. Avoid locations where there is excessive air movement or air disturbances and avoid high humidity locations such as near cases with water misting or fogging devices.

The condenser air inlet is located in the front of the case. Do not block this inlet and do not locate the air inlet near a source of heat. Clearance of 2" minimum must be maintained at the back of the case for condenser air. Clearance at the top of the case should also be at least 8".

Do not Install this where warm condenser air is allowed to re-circulate.

Removing Case From Shipping Skid



CAUTION: If a Johnson bar or pry bar is used to move the case, make certain that the case is lifted under the welded steel frame, and not by the end panels of the case. Damage to the ends will result from lifting under the end panels.

Move the case as near as possible to the final location before removing it from the shipping skid.

Remove the front and rear compressor compartment grills.

Three or Four bolts secure the case to the shipping skid.
Remove, then discard these bolts.

Leveling the Case

The case must be level for proper drainage of defrost water to the condensate evaporator or floor drain.

Check the level of the case along the front rail and along the top of the display pan. Shim under the case frame as needed to level the case. It is recommended that the leveled case be sealed to the floor with an NSF Listed Sealant.

Grill Removal



DANGER: Electrical shock hazard. Do not operate unit with panels removed.

The front and rear grills require removal for case installation.

Both grills must be in place for proper operation of the case. Grills must be reinstalled after case installation.

Condensate Evaporator



NOTICE: Steam from the condensate evaporator may be visible around the base of the merchandiser during normal operation.

This merchandiser may be furnished with an electric condensate evaporator, or a electric condensate pump. Plumbing connections are not required, unless merchandiser is specifically ordered without a condensate evaporator or pump.

The condensate evaporator can be removed from the merchandiser and the condensate drain can be plumbed to an external drain to conserve energy. To remove the condensate evaporator, disconnect the wires at the condensate evaporator. This must be done by a qualified electrician.

This is an open merchandiser and can produce a large amount of condensate water. To ensure that adequate evaporator capacity is available, a high wattage heater is used.

Make sure that the condensate drain line has not been dislodged during shipment and that the drain trap terminates properly over the water reservoir.

Lights

The case comes standard with one led top light and two led vertical lights that are wired into the case. The light switch is located on the top ceiling.

ELECTRICAL INFORMATION & GROUNDING

THIS CASE MUST BE GROUNDED



DANGER: Improper or faulty hookup of electrical components of the case can result in severe injury or death.

All of the cases electrical connections must be performed only by a licensed electrician. All electrical wiring hookups must be done in accordance with all applicable local, regional, or national standards.

The electrical service must be grounded upon installation.

The electrical connection box is accessible from the rear of the case.

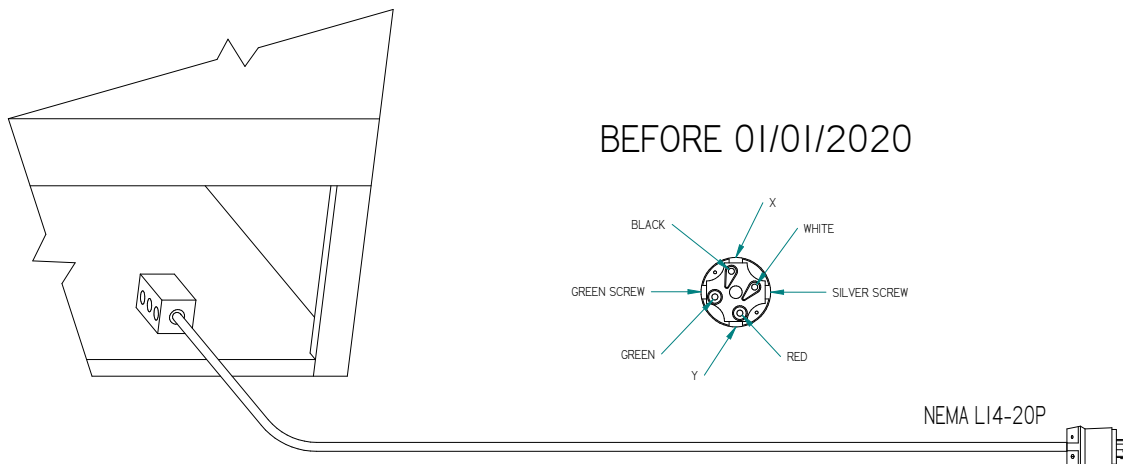

Cord Connected

-The factory installed power cord is properly sized to the amperage requirements of the case. See the electrical data plate located on the rear exterior of the case for the proper circuit size for each case.

- The cord is factory installed protruding from the rear corner of the case.

-A separate circuit for each display case is required to prevent other appliances on the same circuit from overloading the circuit and causing malfunction.

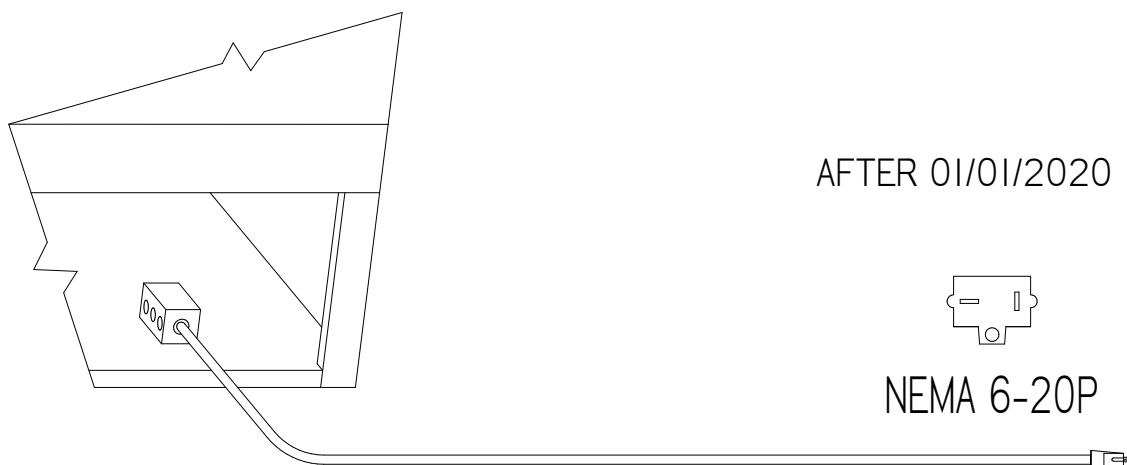

OPERATING INSTRUCTIONS

Initial Start-Up

After completing the items in the installation section of this manual. The case is ready to be put into service. On self-contained models, the service valves on the refrigeration system are back-seated when the unit leaves the factory.

The ERSSHPSC cases are designed to operate at 38° to 40° F. under ambient conditions not to exceed 75° F. and 55% relative humidity.

Nearly all open refrigerated merchandisers operate better when loaded with product than when empty. If a check is made of the case operating temperatures, perform this check with product in the case.

Open refrigerated merchandisers are not intended as storage refrigerators and will not “pull down” room temperature products efficiently. Load case interior with pre-chilled 38° F. or colder product only.

Light Switch And Lights

The light switch is located in the top light housing, under the canopy. This switch operates the interior lights only.

Digital Display

This unit is equipped with a CAREL temperature control with Digital Display. The Display show a number 1 thru 9 to indicate temperature level.

Placing Product In Case

Do not overload the case with product to a point where the top air discharge grill or the bottom air intake grill are blocked, or where the air curtain created by the discharge air is blocked.

LOAD CASE INTERIOR WITH PRE-CHILLED 38° F. OR COLDER PRODUCT ONLY.

Energy Saving Night Curtain

This unit is equipped with an energy saving night curtain.

The night curtain is located in the top inside front of the canopy.

To use the night-curtain pull down and latch on front panel just below the clear acrylic air deflector when case is not in use.



NOTICE: This refrigerated display case is designed to operate in a maximum environment of 75 DEG. F and 55% relative humidity. Exceeding these limits will cause poor case performance and excessive sweating.

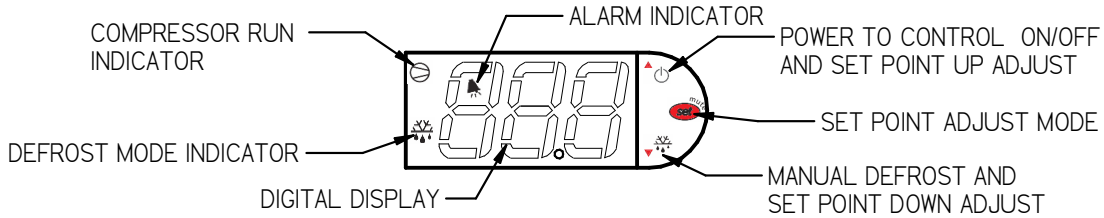

Electronic Temperature Control





Button Overview

	Press and hold this button for three seconds to turn system on (if off) or off (if on). Also used to adjust set point when in set point adjust mode
	Press to enter set point adjust mode, confirm set point changes, and mute alarms.
	Press and hold this button for three seconds to initiate a manual defrost (and cancel defrost if initiated), also adjusts set point down when in set point adjust mode





Powering on control

To turn refrigeration control power on, press and hold  for approx. three seconds. The display will read “On” while the button is depressed. When the control powers on, the display will read the current set point (a number “1” thru “9”). The compressor run indicator  will illuminate on the display, meaning that the compressor is running. (Note: the control may already be in the on mode when shipped from factory).

To turn refrigeration control power to off, press and hold  for approx. three seconds. The display will read “Off” while the button is depressed. When the control powers off the display will flash back and forth between the relative current case temperature and “Off”. The compressor run indicator  will be off on the display. When refrigeration control is in the off mode cabinet lights and evaporator fans will still operate, but the compressor will not turn on causing the case to gradually reach room temperature.





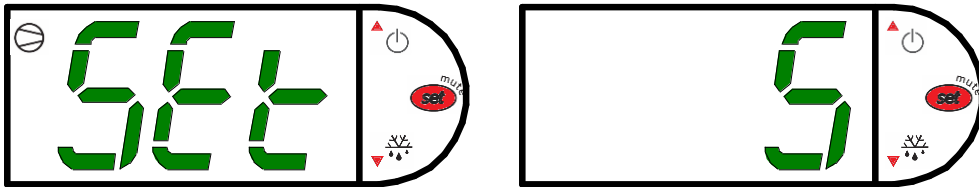

Adjusting the set point

The set point is what determines how cold the display case will hold food and beverage. To adjust the set point press and hold the  button approx. three seconds until the display begins to flash a number. Then press the  button to scroll number up (colder) or press the  button to scroll number lower (warmer). There are nine (9) available set points numbers, the higher the number of the set point, the colder the display case will run, with setting “9” being the coldest and setting “1” being the warmest. Once you have chosen your desired setting press the  button again to confirm your choice.



Entering manual defrost mode

In order to initiate a manual defrost press and hold the  button approx. three seconds. The control will read “dEF” while the button is being held. The defrost is initiated when the defrost mode indicator  illuminates on the display. The control display will then return to reading the case temperature. When the defrost mode indicator  turns off the defrost is complete and the compressor will turn back on illuminating the compressor run indicator .



Error

codes

It is possible for error codes to be displayed on the control screen. In the event of a malfunction an alarm will sound and the alarm indicator  will be displayed on the display. An error code or codes will flash intermittently on the display. If there are multiple codes, the display will continuously cycle through them. The following photo shows error code “E0” as an example.



Mute: You may mute the alarm by pressing and releasing the wrench button. The red ringing bell and all error codes will still be displayed. When the fault is remedied the control will return to normal operation and will automatically clear the codes from the display.

Carel Control Error Codes

EO = Air sensing probe - Open or shorted

E1 = Evap. coil probe - Open or shorted

Code	Description	Cause	Resolution
EO	Temperature probe error	Probe signal is interrupted or short-circuited	Check to ensure probe wires and quick disconnect are secure in control.
E1	Defrost probe error	See EO	Check probe resistance to table below. If 0 resistance is present check wiring insulation. If infinite resistance is present check for breaks in wiring (meter will likely read overload or very high in the mega-ohm range). Ensure that probes are wired per the wiring diagram provided. Replace probe if other remedies fail, or if probe resistance deviates from "Table 3" below
EE	Unit parameter reading error	Operating conditions	Remedy abnormal operating conditions. The control is rated to operate in a range of 14 to 122°F (-10 to 50°C) and less than 90%RH non-condensing.
EF	Operating parameter reading error	See EE	Replace control if problem persists.

CONTROL OPERATION

Electronic Control

This unit is equipped with an Invensys – Ranco model E72R temperature control or a Carel temperature control. The control parameters are set at the factory and cannot be manually changed in the field. Control parameter changes can only be made by downloading a new set of parameters using a program chip supplied by Federal Industries. The pre-set control parameters are listed on the chart in the Settings Chart below.

Operation

The control uses two sensors, one located in the air stream and one located on the evaporator coil. The sensor located in the air stream is referred to as the temperature control sensor. The sensor located on the evaporator coil is referred to as the coil sensor.

The temperature control sensor is located inside the top air duct behind the honeycomb material and is labeled (TEMP). The sensor location is critical for proper operation on the unit. Do not move or relocate this sensor.

The coil sensor is strapped to the evaporator coil and is labeled (DEFROST). This sensor location is critical for proper operation of the unit. Do not move or relocate this sensor.

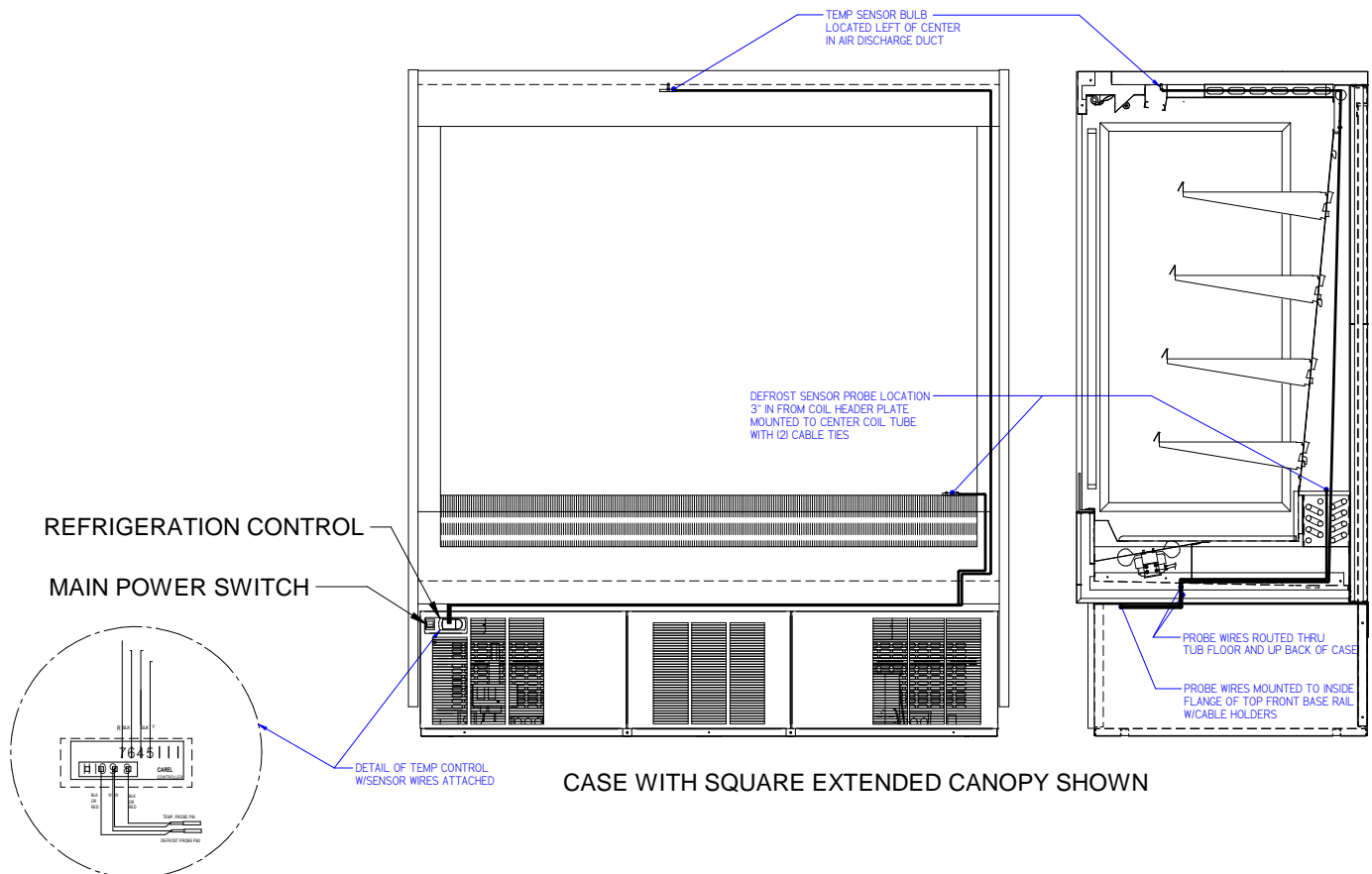

The temperature control is set to cut in at 39 degrees F. The Temp control cuts out at 24 degrees F at the coldest setting 'COLD' and 34 degrees F at the warmest setting, '1' on the control readout

Control Factory Settings

The control parameters are set at the factory and cannot be manually changed in the field. Control parameter changes can only be made by downloading a new set of parameters using a program chip supplied by Federal Industries

TAB	PARAMETER DESCRIPTION	ERSSH
CONFIGURATION	Controller Operation Temperature Units	Degrees Fahrenheit
	Defrost Termination Method	Evaporator Sensor
SET-POINTS	Cut-In Warm	39°F
	Cut-Out Warm	34°F
	Cut-In Cold	39°F
	Cut-Out Cold	24°F
COMPRESSOR	Compressor Minimum On Time	5 minutes
	Compressor Maximum On Time	60 minutes
DEFROST	Defrost Termination Temperature	45°F
DEFROST	Time to First Defrost (hh:mm)	8 hr
	Time to subsequent Defrost	8 hr
	Defrost Max Duration	30 minutes

Electronic control

The control uses two sensors, one located in the air stream and one located on the evaporator coil. The sensor located in the air stream is referred to as the temperature control sensor. The sensor located on the evaporator coil is referred to as the coil sensor.

The temperature control sensor is located inside the top air duct behind the honeycomb material and is labeled (TEMP). The sensor location is critical for proper operation on the unit. Do not move or relocate this sensor.

The coil sensor is strapped to the evaporator coil and is labeled (DEFROST). This sensor location is critical for proper operation of the unit. Do not move or relocate this sensor.

The temperature control is set to cut in at 40 degrees F. The Temp control cuts out at 24 degrees F at the coldest setting 'COLD' and 34 degrees F at the warmest setting, '1' on the control display.

Defrost Cycle

The control is programmed to initiate defrost by two different methods. There are three programmed defrost cycles in the control which will initiate a defrost cycle every 8 hours. The unit does not have a time clock so the defrost cycles cannot be set for any specific time of day.

The controller uses time to initiate the defrost cycle, and temperature to terminate the defrost cycle. The controller also has an 'On demand' defrost feature that will initiate a defrost cycle when the temperature differential between the evaporator temperature and the air temperature is more than 15 degrees for 5 minutes after 30 minutes into the refrigeration cycle.

Minimum Run Timer Feature

The unit controller is programmed to have the condensing unit run a minimum of 5 minutes, regardless of the control temp being satisfied. If the temperature control reaches the cut out set point before 5 minutes, the minimum run time setting in the control will keep the unit in a run cycle mode until the timer reaches 5 minutes. The refrigeration cycle will be off until the temperature control cut in temperature is reached.

This timer typically comes into effect in low ambient conditions where the unit may cycle too frequently to maintain proper product temperature.

Maximum Run Timer Feature

The unit controller is programmed to have the condensing unit run a maximum of 60 minutes. If the unit has not reached cut out temperature setting in 60 minutes, the unit goes into on off cycle. This typically comes into effect in high ambient temperature and relative humidity conditions.

REFRIGERATION OPERATION

Self Contained Models

Refrigeration R404A Charge Prior To 01/01/2020	See Refrigeration And Electrical Data Pages
Refrigeration R449a Charge After 01/01/2020	See Refrigeration And Electrical Data Pages

The self-contained models are shipped from the factory with a completely operational R404A refrigeration system and require no modifications or adjustments upon installation. Case must be installed as per the installation section of this manual to provide proper condensing air cooling.

Self-Contained Refrigeration Operation

The unit temperature is controlled by the Electronic control outlined in the control section of this manual.

Dual Pressure Control (Self-Contained Models Only)

The dual pressure control is used as a safety device and is factory set. The pressure control works on a differential. The low-pressure side is a safety to protect the compressor in the case of refrigerant loss. The high-pressure side is a safety to protect from system failure causing too high of system pressure.

The high side of the pressure control is factory set to 400psi and is not adjustable.

BEFORE 01/01/2020

Low side setting for the R404a cases are set at 40psi differential for the cutout and 60psi for the cut-in.

AFTER 01/01/2020

Low side setting for the R449a cases are set at 40psi differential for the cutout and 60psi for the cut-in.

Shelves

The ERSSHP has 16" solid metal shelves. These shelves are installed at the factory.

The shelves are adjustable in 1-5/8" increments. To adjust the shelves, first remove the shelf from the shelf brackets. Remove the shelf bracket from the shelf standard and reposition as desired. If optional shelf lights are installed, it will be necessary to unplug the shelf light cord before repositioning the shelf brackets.

The shelves can be installed horizontally or slanted at a 10° downward angle. To change the shelf slant, first remove the shelf from the shelf support. Lift the shelf supports up at the back until the brackets can be repositioned in the shelf standard slots. See diagram below

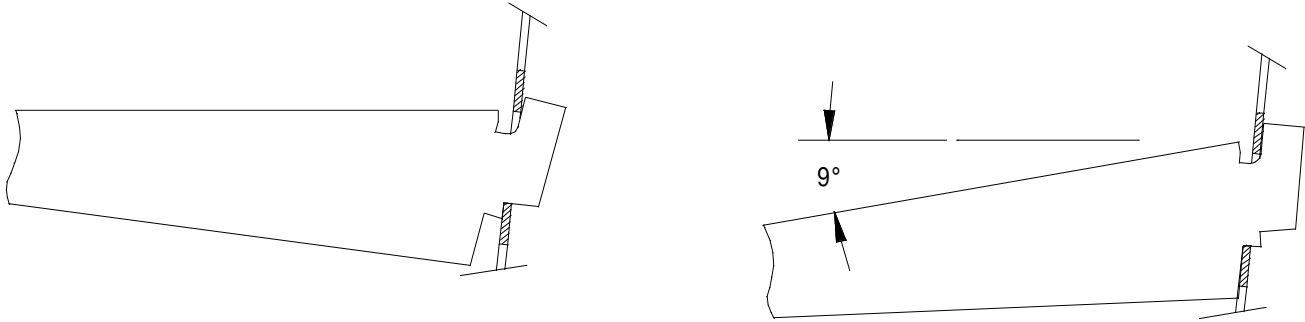

CAUTION:



Do not place more than 100 lbs. of product on a ERSSHP478 OR ERSSHP678 shelf.

Do not place more than 80 lbs. of product on a ERSSHP378 shelf.

Damage to the shelf standard may occur if the shelf is overloaded.

CLEANING INSTRUCTIONS

Cleaning the Condenser Filter

This refrigerated case is equipped with a reusable condenser coil filter, which filters large dust particles from the air before it enters the condenser coil fins. It is very important that this filter be cleaned every two weeks to maintain proper refrigeration performance and prevent compressor failure. **FAILURE TO CLEAN THE CONDENSER FILTER WILL VOID THE COMPRESSOR WARRANTY.**

1. The center grille in the base contains the condenser air filter. To access the filter lift grille from the bottom, tilt bottom forward and slide top of grille down and out of channel. The filter will slide out the top of the grille.
2. Wash the filter using warm soapy water. Rinse the filter and let it dry. **NOTE: Do not clean the filter in a dishwasher.**
3. Apply a generous coat of filter coat adhesive to both sides of the filter. (Filter coat adhesive is available through any restaurant supply chain distributor). **NOTE: Failure to coat the filter with a fresh coat of filter adhesive after cleaning will cause ineffective filter operation. This will lead to plugging of the condenser coil, affecting refrigeration performance and can cause compressor failure.**
4. Despite the presence of the filter, it is necessary to check and clean the condenser coil every 3 months or as necessary. Refer to the instructions outlined on next page in Cleaning Condenser Coil.
5. Reinstall the filter.

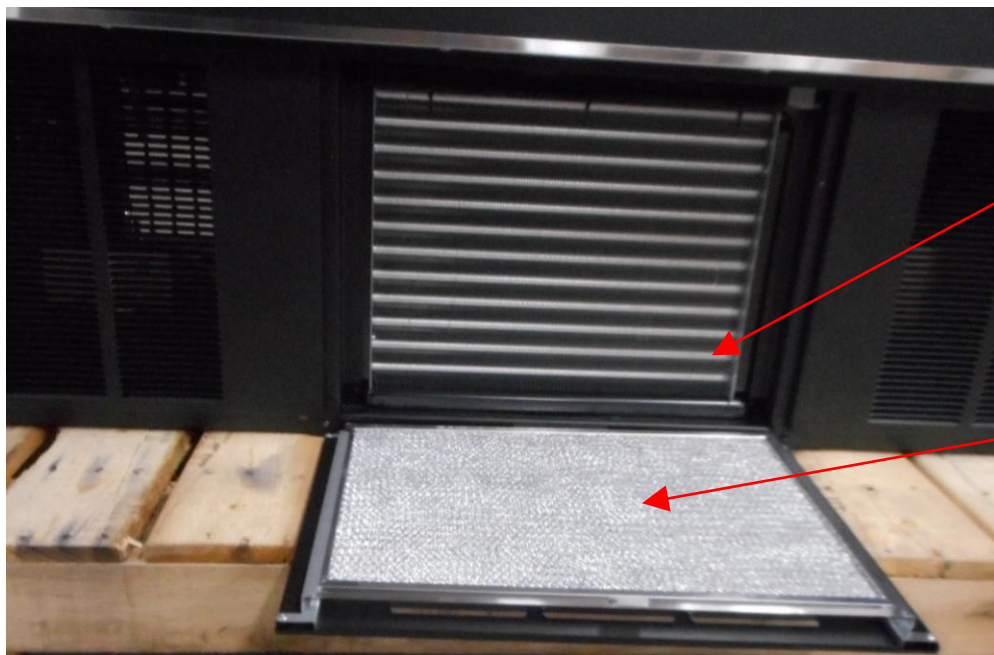

VACUUM FRONT
SURFACE OF
CONDENSER COIL

THE FRONT GRILLE IS
REMOVABLE AND HOLDS
A FILTER WHICH IS
CLEANABLE

Cleaning Condenser Coil

1. Disconnect the power to the unit.
2. Remove the front grill and vacuum the front surface of the condenser coil, moving the vacuum nozzle vertically. This should be done every two weeks. **NOTE: Be careful not to bend or otherwise damage the condenser coil fins. Moving the vacuum nozzle horizontally will cause bend the fins. Bent coil fins will affect condensing unit performance.**

Cleaning Condenser Coil Continued



NOTICE:

Condenser coil or optional air filter must be cleaned a minimum of twice per month to insure proper refrigeration performance and prevent compressor failure. In some environments, it may be necessary to clean more frequently. FAILURE TO CLEAN CONDENSER COIL WILL VOID COMPRESSOR WARRANTY.

It is very important that the air filter is cleaned twice per month and the condenser coil every 3 months or as needed to insure proper refrigeration performance and to prevent compressor failure. In some environments, it may be necessary to clean more frequently. Failure to clean condenser filter and condenser coil will void condenser warranty. This procedure is for Self-Contained models. The remote condenser coil must also be cleaned at same intervals.

Acrylic Air Deflector Cleaning



NOTICE:

Clear acrylic air deflector requires special washing procedures to prevent hazing and yellowing of material.

NEVER USE paper towels (wet or dry) for cleaning or drying and never use a dry towel.

NEVER USE glass cleaner of any kind.

Lightly dust (not wipe) surface with a damp Micro Fiber towel or chamois. The surface can then be washed using a small amount of dishwashing detergent such as Dawn or Joy and lukewarm water. Use a Micro Fiber towel or chamois, applying only light pressure. The cloth or chamois must be kept free of grit by frequently rinsing. Rinse surface with clear water and dry by blotting with a damp Micro Fiber towel or chamois.

Daily Cleaning

The case should be cleaned thoroughly, as described in the weekly cleaning section, before it is used for the first time.



NOTICE: Avoid splashing or soaking any electrical components with water to prevent electrical damage to the case.



NOTICE: Shut off lights and power switches and remove all products from case. Allow sufficient time for the unit to reach room temperature before proceeding with cleaning.



NOTICE: Remove all products from the case before proceeding with cleaning procedure.



NOTICE: Acrylic air deflector requires special washing procedures to prevent hazing and yellowing of material. Clean as described in “Acrylic Air Deflector Cleaning” section of this manual.

Note: For major spills or foreign material buildup use complete weekly cleaning instructions.

Note: Detergents are not recommended and do not use abrasive cleaners or pads to prevent scratching of surfaces.

1. Dip rag in warm soapy water and ring out thoroughly. Wipe complete interior of case and dry with soft dry towel.
2. The remaining exterior surface should be wiped down using any ammoniated cleaners or soapy warm water and dried with soft dry towel.
3. **IMPORTANT:** Cleaning the clear acrylic plastic front air deflector requires special care to prevent hazing and yellowing of material. Clean as described in “Acrylic Air Deflector Cleaning” section of this manual.

Weekly Cleaning

**NOTICE:**

Avoid splashing or soaking any electrical components with water to prevent electrical damage to the case.

**NOTICE:**

Shut off lights and power switches and remove all products from case. Allow sufficient time for the unit to reach room temperature before proceeding with cleaning.

**NOTICE:**

Remove all products from case before proceeding with cleaning procedure.

**NOTICE:**

Acrylic front air deflector requires special washing procedures to prevent hazing and yellowing of material.

Note: Detergents are not recommended and do not use abrasive cleaners or pads to prevent scratching of surfaces.

1. Remove interior shelving from unit as described in the “Shelving Installation and Removal” section of this manual.
2. Dip rag in warm soapy water and ring out thoroughly. Clean all shelves and shelf brackets and dry with soft dry towel.
3. Dip rag in warm soapy water and ring out thoroughly. Clean the tower side panels, tower inner panels and inside both tower ends. Dry with soft dry towel
4. Lift the display decks up and out of evaporator tub.
5. Clean the display deck(s) using warm soapy water and a brush. Rinse thoroughly and allow dry. Wipe off fan shroud assembly (do not rinse or submerge fan motors).
6. Clean the entire interior of the case using warm soapy water. Wipe off all soapy water with a damp cloth and allow to dry. (DO NOT use solvents such as Acetone, Benzene, Carbon Tetrachloride, and Lacquer Thinners)
- 7. IMPORTANT: Cleaning the clear acrylic plastic front air deflector requires special care to prevent hazing and yellowing of material. Clean as described in “Acrylic Air Deflector Cleaning” section of this manual.**
8. Reassemble all components in reverse order.

NOTE: Depending on the amount of usage and spillage of foreign material, some fasteners may have to be removed and parts disassembled to allow proper cleaning of the unit.

SERVICE INFORMATION

CAUTION
RISK OF ELECTRIC SHOCK

DISCONNECT POWER
BEFORE SERVICING UNIT

Before any service work is performed on the case, make sure all power is disconnected to the case.

To find a service company in your area, please visit our website at www.federalindustries.com. There you can also find self-service tools to help you get the answers you need faster!

For Warranty Service Requests & ALL Technical Support please contact:

- Phone: (800) 356-4206 and choose the Tech Support/Warranty Option
- Email: Service@federalind.com

For Warranty Compressors please contact the Parts Department:

- Phone: (800) 356-4206 and choose the Warranty Parts Option
- Email: Parts@Federalind.com



Federal Industries has partnered with Parts Town for ALL Non-Warranty Part Identification, Pricing, Lead Times, Orders & Freight Quotes. Please contact Parts Town directly if you need parts:

- Website: PartsTown.com
- Email: CustomerService@PartsTown.com
- Phone: 833-809-8188



Pre-Service Checklist

You may avoid the cost and inconvenience of an unnecessary service call by first reviewing this checklist of frequently encountered situations that can cause unsatisfactory case performance.



CAUTION: Before servicing case turn off power at the main breaker of fuse box.

Case Does Not Operate

- Check for disconnected power supply.
- Check for tripped breaker or blown fuse.

Case Temperature Too Warm

Check that top air discharge grill and/or bottom air intake grill are not blocked.

Check for a blocked or dirty condenser coil.

Check that there are no outside air disturbances in or around cases. These disturbances can be caused by nearby doors or entrances, overhead ceiling fans or air diffuser vents, direct sunlight, or other heat sources. The location of open refrigerated merchandisers is critical to case performance.

Make sure that warm product is not being installed inside the case. All product must be pre-chilled prior to loading for proper case performance.

Check temperature/pressure control for proper settings.

Check cold air flow. Lack of or no air flow may indicate a blocked evaporator coil or defective evaporator fan motor. Contact a qualified service company if there is no air flow inside case.

Lights Do Not Operate

Check that light switch located in top light housing is “on”.

Check that all plugs are properly seated in the light ends & sockets.

Overflow of Condensate Evaporator

Check that drain line is properly located over the water reservoir.

Check that store conditions do not exceed 75° and/or 55% relative humidity for prolonged periods of time.

Special Service Situations

There are rare occasions when the refrigerant charge must be evacuated from a case in order to perform service work. In those situations, Federal Industries recommends that the refrigerant charge be evacuated into a recovery system to prevent the possibility of hydrofluorocarbons (HFC's) from being released into the atmosphere. The release of HFC's into the atmosphere is a source of greenhouse gases.

If moisture or liquid is observed around or under a Federal Industries case, an immediate investigation should be made by qualified personnel to determine the source of the moisture or liquid. The investigation made should determine if the case is malfunctioning or if there is a simple housekeeping problem.

Moisture or liquid around or under a case is a potential slip/fall hazard for persons walking by or working in the general area of the case. Any case malfunction or housekeeping problem that creates a slip/fall hazard around or under a case should be corrected immediately.

SALE & DISPOSAL

Owner Responsibility

If you sell or give away your Federal Industries case, you must make sure that all safety labels and the Installation-Service Manual are included with it. If you need replacement labels or manuals, Federal Industries will provide them free of charge. Contact the Customer Service Department at Federal Industries at (800) 356-4206.

The Customer Service Department at Federal Industries should be contacted at the time of sale or disposal of your case so records may be kept of its new location.

If you sell or give away your Federal Industries case and you evacuate the refrigerant charge before shipment, Federal Industries recommends that the charge be evacuated into a recovery system to reduce the possibility of HFC's from being released into the atmosphere. The release of HFC's into the atmosphere is a source of greenhouse gases.

REFRIGERATION & ELECTRICAL DATA

AFTER 01/01/2020

<u>Model</u>	<u>ERSSHP378SC-6</u>	
<u>ELECTRICAL</u>		
Power Supply, Volts	208-240Volts	
Frequency	60 Hertz	
Phase	1 Phase	
Number of Wires	2 + Ground	Plug configuration NEMA 6-20P
	<u>AMPS</u>	<u>VOLTS</u>
Compressor		
RLA	4.3	208-240
LRA	31.0	208-240
Condenser Fan Motor	0.6	208-240
Evaporator Fan Motor	0.4	120
Lights	0.8	120
Condensate Pan Heater	5.0	240

Refer to the rating plate data attached to the rear of the case for Maximum Fuse Size and Minimum Circuit Ampacity.

REFRIGERATION

Self-Contained Models

Refrigeration R449a Charge Self Contained	3 Pounds
---	-----------------

The self-contained models are shipped from the factory with a completely operational R449a refrigeration system and require no modifications or adjustments upon installation. Case must be installed as per the installation section of this manual to provide proper condensing air cooling.

Self-Contained Refrigeration Operation

The unit temperature is controlled by the Electronic control and timers outlined in the control section of this manual.

Note: The condenser fan runs continuously.

REFRIGERATION & ELECTRICAL DATA

BEFORE 01/01/2020

Model

ERSSH378SC-5

ELECTRICAL

Power Supply, Volts

120/208-240Volts

Frequency

60 Hertz

Phase

1 Phase

Number of Wires

3 + Ground

Plug configuration NEMA L14-20P

AMPS

VOLTS

Compressor

RLA

4.3

208-240

LRA

31.0

208-240

Condenser Fan Motor

0.6

208-240

Evaporator Fan Motor

0.4

120

Lights

0.8

120

Condensate Pan Heater

5.0

240

Refer to the rating plate data attached to the rear of the case for Maximum Fuse Size and Minimum Circuit Ampacity.

REFRIGERATION

Self-Contained Models

Refrigeration R404A Charge Self Contained

3 Pounds

The self-contained models are shipped from the factory with a completely operational R404A refrigeration system and require no modifications or adjustments upon installation. Case must be installed as per the installation section of this manual to provide proper condensing air cooling.

Self-Contained Refrigeration Operation

The unit temperature is controlled by the Electronic control and timers outlined in the control section of this manual.

Note: The condenser fan runs continuously.

REFRIGERATION & ELECTRICAL DATA

AFTER 01/01/2020

Model

ERSSHP478SC-6

ELECTRICAL

Power Supply, Volts

208-240 Volts

Frequency

60 Hertz

Phase

1 Phase

Number of Wires

2 + Ground Plug configuration NEMA 6-20P

AMPS

VOLTS

Compressor

RLA

5.7

208-240

LRA

31.0

208-240

Condensar Fan Motor

0.7

208-240

Evaporator Fan Motor (2)

0.4ea

120

Lights

0.8

120

Condensate Pan Heater

5.0

240

Refer to the rating plate data attached to the rear of the case for Maximum Fuse Size and Minimum Circuit Ampacity.

REFRIGERATION

Self-Contained Models

Refrigeration R449a Charge Self Contained	4 Pounds
---	-----------------

The self-contained models are shipped from the factory with a completely operational R449a refrigeration system and require no modifications or adjustments upon installation. Case must be installed as per the installation section of this manual to provide proper condensing air cooling.

Self-Contained Refrigeration Operation

The unit temperature is controlled by the Electronic control and timers outlined in the control section of this manual.

Note: The condenser fan runs continuously.

REFRIGERATION & ELECTRICAL DATA

BEFORE 01/01/2020

Model

ERSSH478SC-5

ELECTRICAL

Power Supply, Volts

120/208-240 Volts

Frequency

60 Hertz

Phase

1 Phase

Number of Wires

3 + Ground Plug configuration NEMA L14-20P

AMPS

VOLTS

Compressor

RLA

5.7

208-240

LRA

31.0

208-240

Condensar Fan Motor

0.7

208-240

Evaporator Fan Motor (2)

0.4ea

120

Lights

0.8

120

Condensate Pan Heater

5.0

240

Refer to the rating plate data attached to the rear of the case for Maximum Fuse Size and Minimum Circuit Ampacity.

REFRIGERATION

Self-Contained Models

Refrigeration R404A Charge Self Contained	4 Pounds
---	-----------------

The self-contained models are shipped from the factory with a completely operational R404A refrigeration system and require no modifications or adjustments upon installation. Case must be installed as per the installation section of this manual to provide proper condensing air cooling.

Self-Contained Refrigeration Operation

The unit temperature is controlled by the Electronic control and timers outlined in the control section of this manual.

Note: The condenser fan runs continuously.

REFRIGERATION & ELECTRICAL DATA

AFTER 01/01/2020

Model

ERSSHP678SC-6

ELECTRICAL

Power Supply, Volts

208-240 Volts

Frequency

60 Hertz

Phase

1 Phase

Number of Wires

2 + Ground Plug configuration NEMA 6-20P

AMPS

VOLTS

Compressor

RLA

7.7

208-240

LRA

54.0

208-240

Condensar Fan Motor

0.7

208-240

Evaporator Fan Motor (3)

0.4ea

120

Lights

0.8

120

Condensate Pan Heater

5.0

240

Refer to the rating plate data attached to the rear of the case for Maximum Fuse Size and Minimum Circuit Ampacity.

REFRIGERATION

Self-Contained Models

Refrigeration R449a Charge Self Contained	4.25 Pounds
---	--------------------

The self-contained models are shipped from the factory with a completely operational R449a refrigeration system and require no modifications or adjustments upon installation. Case must be installed as per the installation section of this manual to provide proper condensing air cooling.

Self-Contained Refrigeration Operation

The unit temperature is controlled by the Electronic control and timers outlined in the control section of this manual.

Note: The condenser fan runs continuously.

REFRIGERATION & ELECTRICAL DATA

BEFORE 01/01/2020

Model

ERSSH678SC-5

ELECTRICAL

Power Supply, Volts 120/208-240 Volts
Frequency 60 Hertz
Phase 1 Phase
Number of Wires 3 + Ground Plug configuration NEMA L14-20P

AMPS **VOLTS**

Compressor		
RLA	7.7	208-240
LRA	54.0	208-240
Condensar Fan Motor	0.7	208-240
Evaporator Fan Motor (3)	0.4ea	120
Lights	0.8	120
Condensate Pan Heater	5.0	240

Refer to the rating plate data attached to the rear of the case for Maximum Fuse Size and Minimum Circuit Ampacity.

REFRIGERATION

Self-Contained Models

Refrigeration R404A Charge Self Contained	4.25 Pounds
---	--------------------

The self-contained models are shipped from the factory with a completely operational R404A refrigeration system and require no modifications or adjustments upon installation. Case must be installed as per the installation section of this manual to provide proper condensing air cooling.

Self-Contained Refrigeration Operation

The unit temperature is controlled by the Electronic control and timers outlined in the control section of this manual.

Note: The condenser fan runs continuously.

REPLACEMENT PARTS

MODEL ERSSHP378SC-5 Before 01/01/2020

MODEL ERSSHP378SC-6 After 01/01/2020

Part Description

Part Number

Refrigeration System

ERSSHP378SC

Condensing Unit (Self-Contained Only)	30-20512
Compressor (Replacement) AUG 2016	30-20623
Compressor (Replacement) Before AUG. 2016	30-18052
Evaporator Coil	33-13283
Expansion Valve R404A Before 01/01/2020	32-19416
Expansion Valve R449a AFTER 01/01/2020	32-21172
Temperature Control	32-19865-1
Control Probes Defrost	32-19094
Control Probes Temperature	32-19866
Pressure Control – Dual	32-51009
Evaporator Fan Motor 120V Before 01/01/2020	41-11628
Evaporator Fan Motor 220V After 01/01/2020	41-15925
Evaporator Fan Blade	72-14569
Filter Drier	32-12626

Electrical Components

Condensate PTC Heater 240V-600W	40-19392
Top Light	42-20870-29F35
Vertical Lights	42-20870-40F35
24V. Power Supply	39-20555
Light Switch (On/Off)	41-11066
Power Switch Toggle Before 01/01/2020	41-13733
Power Switch Rocker AFTER 01/01/2020	41-18186
Top Anti Sweat Heater 120V Before 01/01/2020	43-14892
Top Anti Sweat Heater 220V After 01/01/2020	43-19467
Power Cord L14-20P Before 01/01/2020	43-15268
Power Cord 6-20P After 01/01/2020	43-19090
After 01/01/19	
Top Light	42-20871-25C35
Vertical Lights	42-20871-42C35
24V. Power Supply	39-20986

Miscellaneous Components

Condenser Filter AFTER 01/01/2020	16-13647
Price Tag Molding	W11329-21
Thermometer	32-13662
Metal Shelf 16"	M15171-2
Shelf Bracket Left Hand	M15169-LA
Shelf Bracket Right Hand	M15169-RA
End Glass	50-19488
Drain 1" NPS	84-70225
Drain Trap Assembly	SA-1513
Acrylic Air Deflector	15-19222-6
Condensate Pan Ass'y – PTC Heaters 240V	SA5125
Before 01/01/19	
Acrylic Air Deflector	15-19222-3
Condensate Pan Ass'y – PTC Heaters 240V	SA5406-2

REPLACEMENT PARTS

MODEL ERSSHP478SC-5 Before 01/01/2020

MODEL ERSSHP478SC-6 After 01/01/2020

Part Description

Part Number

Refrigeration System

ERSSHP478SC

Condensing Unit (Self-Contained Only)	30-17888
Compressor (Replacement)	30-18053
Evaporator Coil	33-11541
Expansion Valve R404A Before 01/01/2020	32-19416
Expansion Valve R449a After 01/01/2020	32-20887
Temperature Control	32-19865-1
Control Probes Defrost	32-19094
Control Probes Temperature	32-19866
Pressure Control – Dual	32-51009
Evaporator Fan Motor 120V Before 01/01/2020	41-11628
Evaporator Fan Motor 220V After 01/01/2020	41-15925
Evaporator Fan Blade	72-13316
Filter Drier	32-11561

Electrical Components

Condensate PTC Heater 240V-600W	40-19392
Top Light	42-20870-40F35
Vertical Lights	42-20870-40F35
24V. Power Supply	39-20555
Light Switch (On/Off)	41-11066
Power Switch Toggle Before 01/01/2020	41-13733
Power Switch Rocker AFTER 01/01/2020	41-18186
Top Anti Sweat Heater 120V Before 01/01/2020	43-14891
Top Anti Sweat Heater 240V AFTER 01/01/2020	43-15926
Power Cord L14-20P Before 01/01/2020	43-15268
Power Cord 6-20P After 01/01/2020	43-19090
After 01/01/19	
Top Light	42-20870-38C35
Vertical Lights	42-20870-42C35
24V. Power Supply	39-20986

Miscellaneous Components

Condenser Filter AFTER 01/01/2020	16-13647-2
Price Tag Molding	W11329-22
Metal Shelf 16"	M15171-1
Shelf Bracket Left Hand	M15169-LA
Shelf Bracket Right Hand	M15169-RA
End Glass	50-19488
Condensate Pan Ass'y – PTC Heaters 240V	SA5125
Condensate Pan Bracket	63-19441
Drain 1" NPS	84-70225
Drain Trap Assembly	SA-1513
Acrylic Air Deflector	15-19222-7
Before 01/01/19	
Acrylic Air Deflector	15-19222-2
Condensate Pan Ass'y – Calrod Heater 240V	SA-1879

REPLACEMENT PARTS

MODEL ERSSHP678SC-5 Before 01/01/2020

MODEL ERSSHP678SC-6 After 01/01/2020

Part Description	Part Number
<u>Refrigeration System</u>	
Condensing Unit (Self-Contained Only)	30-17889
Compressor (Replacement)	30-18054
Evaporator Coil	33-11542
Expansion Valve R404A Before 01/01/2020	32-18245
Expansion Valve R449a After 01/01/2020	32-20887
Temperature Control	32-19865-1
Control Probes Defrost	32-19094
Control Probes Temperature	32-19866
Pressure Control – Dual	32-51009
Evaporator Fan Motor 120V Before 01/01/2020	41-11628
Evaporator Fan Motor 220V After 01/01/2020	41-15925
Evaporator Fan Blade	72-13316
Filter Drier	32-11561
<u>Electrical Components</u>	
Condensate PTC Heater 240V-600W	40-19392
Top Light	42-20870-62F35
Vertical Lights	42-20870-40F35
24v. Power Supply	39-20555
Light Switch (On/Off)	41-11066
Power Switch Toggle Before 01/01/2020	41-13733
Power Switch Rocker AFTER 01/01/2020	41-18186
Top Anti Sweat Heater 120V Before 01/01/2020	43-14893
Top Anti Sweat Heater 240V AFTER 01/01/2020	43-19113
Power Cord L14-20P Before 01/01/2020	43-15268
Power Cord 6-20P After 01/01/2020	43-19090
After 09/01/19	
Top Light	42-20870-60C35
Vertical Lights	42-20870-42C35
24v. Power Supply	39-20986
<u>Miscellaneous Components</u>	
Condenser Filter AFTER 01/01/2020	16-13647-2
Price Tag Molding	W11329-24
Metal Shelf 16"	M15171
Shelf Bracket Left Hand	M15169-LA
Shelf Bracket Right Hand	M15169-RA
End Glass	50-19488
Condensate Pan Ass'y – PTC Heaters 240V	SA5125
Condensate Pan Bracket	63-19441
Drain 1" NPS	84-70225
Drain Trap Assembly	SA-1513
Acrylic Air Deflector	15-19222-8
Before 01/01/19	
Acrylic Air Deflector	15-19222-1
Condensate Pan Ass'y – Calrod Heaters 240V	SA-1879

ERSSHP DISPLAY AREA & VOLUME

BEFORE 01/01/2020

	ERSSHP378	ERSSHP478	ERSSHP678
CUBIC FT. PER SHELF	2.9	3.9	6.9
CUBIC FT. DISPLAY DECK	3.8	5.0	7.8
TOTAL CUBIC FT.	15.4	20.6	35.4
SQUARE INCHES PER SHELF	535.0	711.0	1095.0
SQUARE INCHES DISPLAY DECK	690.0	917.0	1413.0
TOTAL SQUARE INCHES	2830.0	3761.0	5793.0
SHELF WIDTH	33.44	44.44	68.44

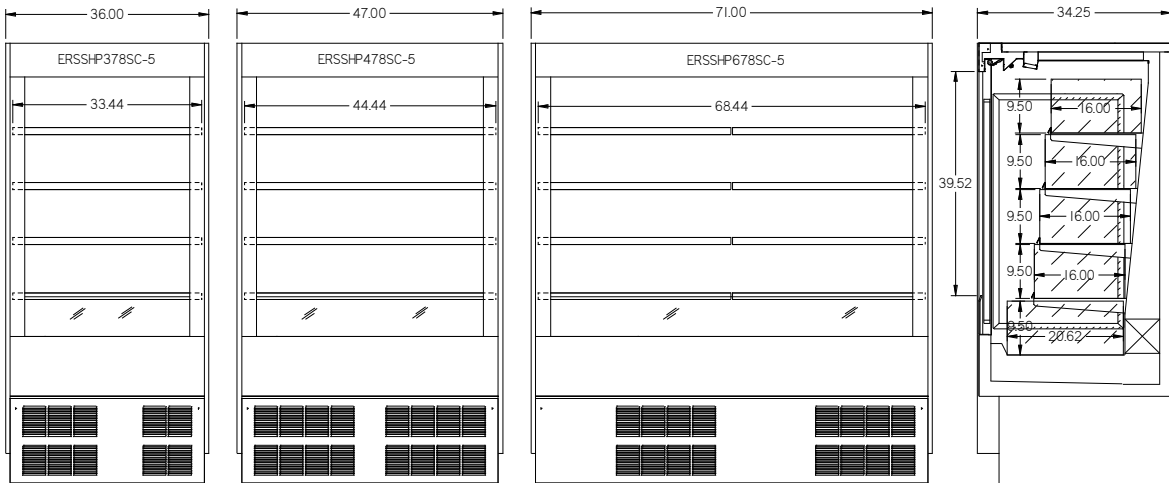

AFTER 01/01/2020

	ERSSHP378	ERSSHP478	ERSSHP678
CUBIC FT. PER SHELF	2.9	3.9	6.9
CUBIC FT. DISPLAY DECK	3.8	5.0	7.8
TOTAL CUBIC FT.	15.4	20.6	35.4
SQUARE INCHES PER SHELF	535.0	711.0	1095.0
SQUARE INCHES DISPLAY DECK	690.0	917.0	1413.0
TOTAL SQUARE INCHES	2830.0	3761.0	5793.0
SHELF WIDTH	33.44	44.44	68.44

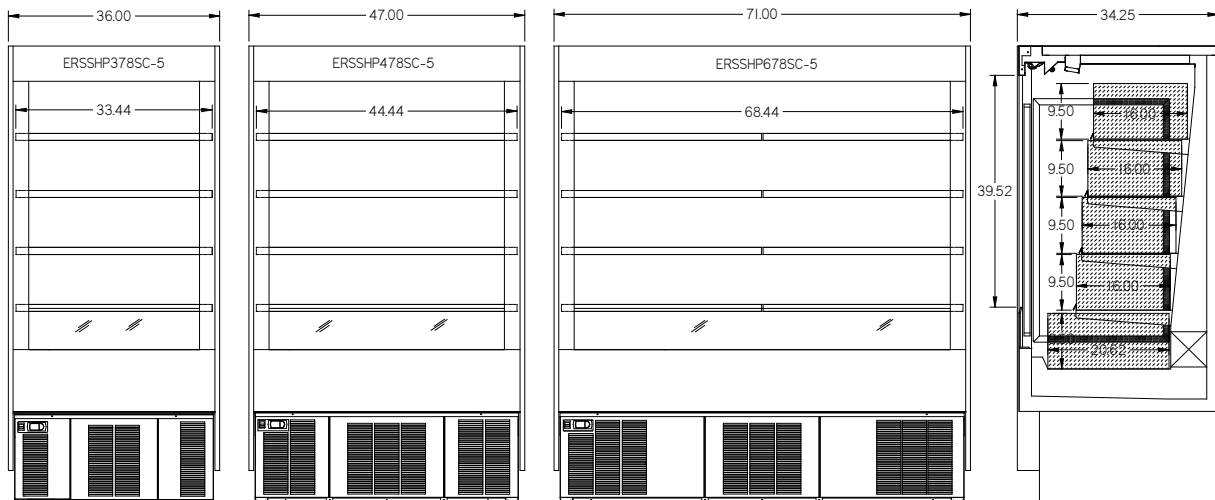

LIGHT WIRING BEFORE 01/01/19

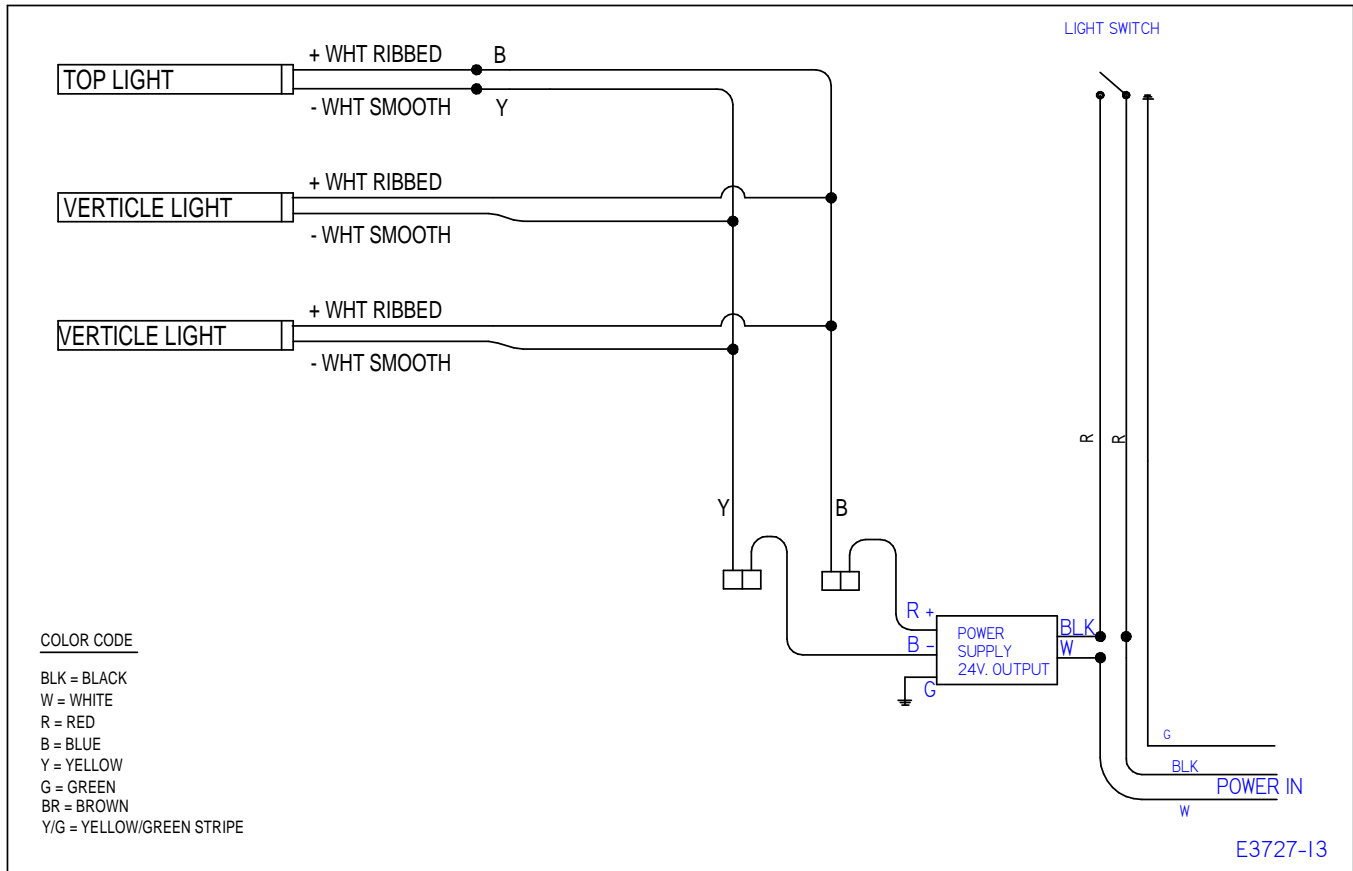

California Residents Only.

 **WARNING**

This product can expose you to chemicals including chromium which is known to the State of California to cause cancer and birth defects or other reproductive harm. For more information go to www.P65Warnings.ca.gov

